



ARLEC

User Instructions

Used for model: EALC070, EALC090, EALC125, EALC150, EALC180



(Picture is only for reference purposes only)



Products in the carton:

Once open the carton, pls. check everything is complete in the package, they are as follows:

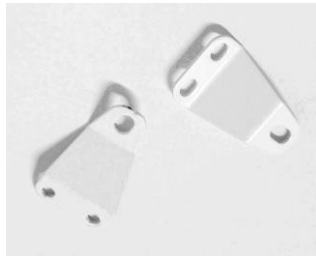

C



D



E



F



G



H



A body

B feet

C fixing flat

D small expansion screw

E hook

F big expansion screw

G screw for feet

H screw

Models:

Models:	Power (W)	Rated voltage	Rated frequency	fins
EALC070	700	220-240V~	50Hz	4
EALC090	900	220-240V~	50Hz	5
EALC125	1250	220-240V~	50Hz	5
EALC150	1500	220-240V~	50Hz	8
EALC180	1800	220-240V~	50Hz	10

Important safeguards:

In order to avoid any fire, electric shock or injury risk, please read and comply with the following instructions:

- 1) Our quality assurance doesn't cover damages caused by non-compliance with this operation manual.
- 2) The appliance must connect to the power with voltage equivalent to the rated voltage on the label of the electrical appliance.
- 3) Never use the heater near the gas, explosives, or inflammable or explosive goods.



- 4) **Warning:** To avoid overheating, any kind of articles, such as clothes, blankets, curtains and etc. is prohibited from covering the heater.
- 5) When operating, temperature on the surface of the electrical appliance will rise.
- 6) The appliance is not intended for use by persons (including children) with reduced physical sensory or mental capabilities, or lack of experience and knowledge, unless they have been given supervision or instruction concerning use of the appliance by a person responsible for their safety.
- 7) Do not place the appliance under a plug or socket.
- 8) In case of damage or fault, repair must be made by the sales agent or at the specialized maintenance center so as to avoid further damage.
- 9) Before the maintenance or cleaning work is finished, the appliance mustn't be connected to the power.
- 10) Do not place the appliance close to bathrooms, shower rooms, or pools, etc. The appliance is only for indoor use.

1. Installation location instructions

- 1) This appliance can be wall-mounted or free-standing, pls. choose the suitable place to install it.
- 2) Do not install this product near furniture, curtains or any other appliances.
- 3) Do not install this appliance in the corner of the wall.
- 4) Be sure the installation location is far from the door and window.
- 5) It must install in a safe location that people who are taking shower cannot touch the appliance's switch or controller.

2. Installation instructions for free-standing type

Take out the feet from the carton, and place the legs at the bottom of heater in the first and last fins and screw them on. Make sure the hole on the body correctly matches the hole on the feet. Shown as the following pictures:

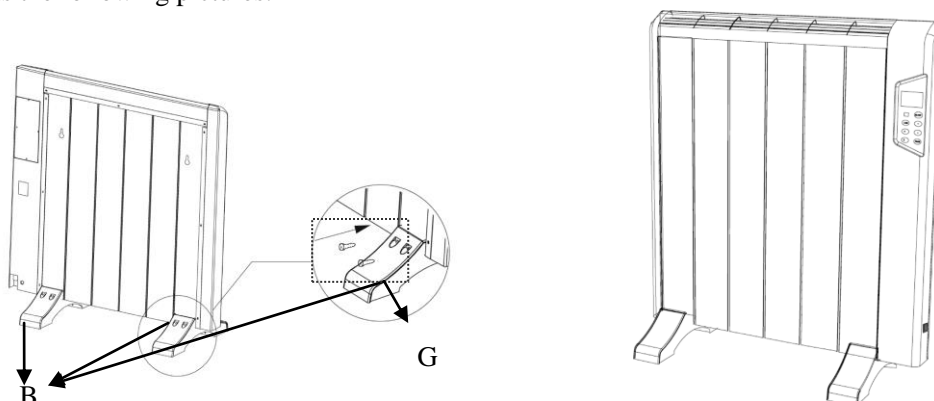

3. Installation instructions for wall-mounted type

1) Before fixing heater on a wall, be sure that once unit installed it must be kept at a minimum distance (shown in below pictures) from the wall. (Unit: MM)

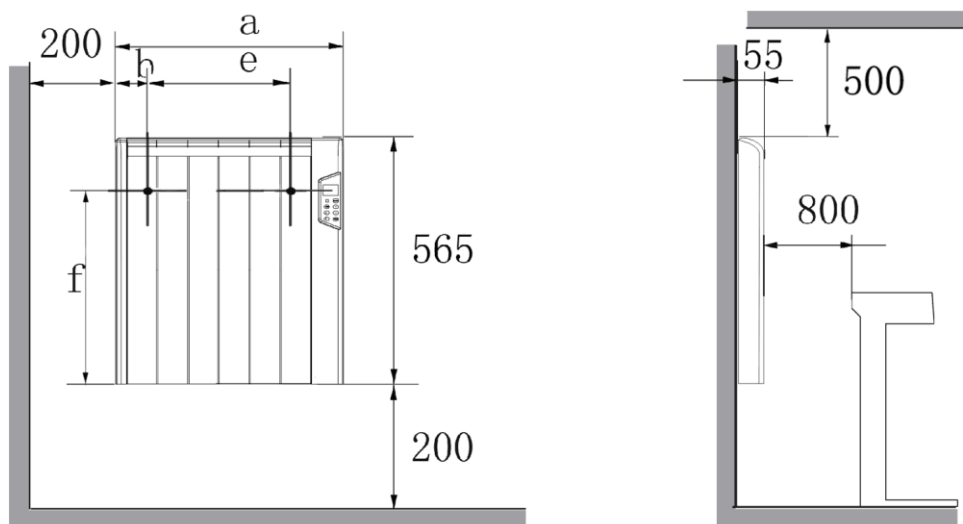

● The distances marked above vary depending on the model of heater that you have bought. The dimensions are as follows:

Models	a (mm)	b (mm)	e (mm)	f (mm)
EALC070	434	93	220	495
EALC090	510	93	296	495
EALC125	662	93	448	495
EALC150	738	93	524	495
EALC180	890	93	676	495

First, drill 2 holes on the wall (diameter: 10mm; depth: 60mm), the 2 holes' distance is corresponding to the "e" position shown on the above pictures. Fix the hooks (letter E item as below picture) on the wall with the big expansion screws (letter F item as below picture). Use screws (letter H item as below picture) to fix the fixing flat (letter C item as below picture) to the body appliance. (Notes: the fixing flat usually fixed on the holes in the first 2nd and last 2nd fins at

the back body of the appliance. All models need 2 fixing flats except the EALC070 which needs only 1 fixing flat.) Pls. see below pictures for installation.

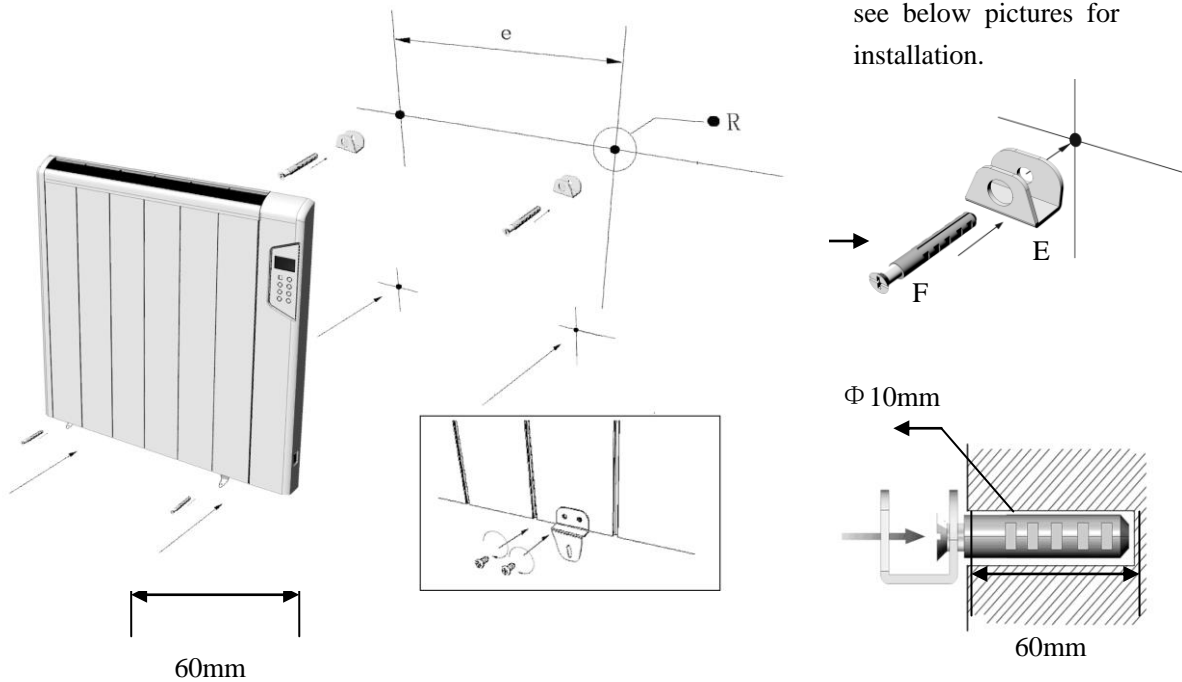

- 2) Hang the appliance on the hooks (shown as below). Be sure the bracket is totally hung on the hook. Once the appliance hung on the hook, try to pull down the appliance, if the appliance is unmovable, it means that the appliance is hooked. Mark 2 hole positions on the wall for the two fixing flats (letter C item as below picture), and drill the holes at diameter 4mm, depth 25mm. Fix the appliance on the wall by screwing the fixing flat on the drilling hole on the wall. (Pls. see below pictures for installation.)

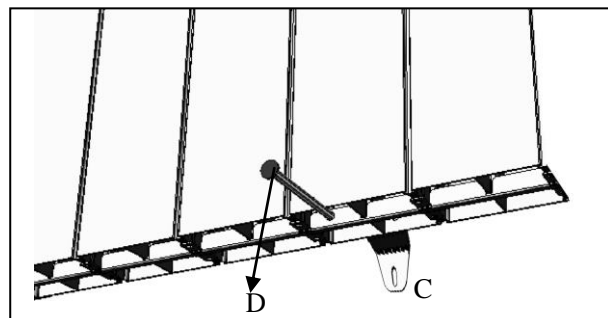
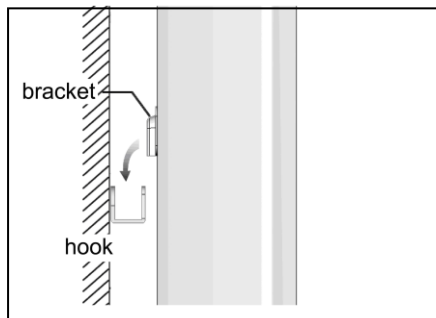

4. Electrical connection

Before plugging into the socket, pls. make sure your power supply and voltage conform to the labeled power and voltage on the appliance, also the plug matches the socket.

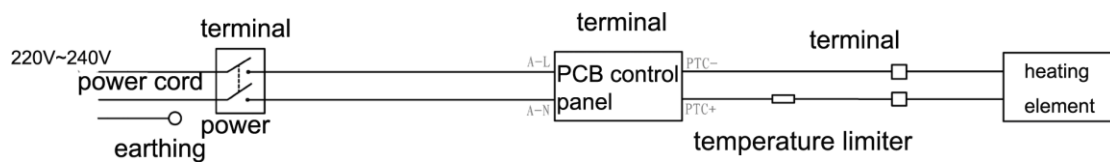

This product is in compliance with the electromagnetic interference prevention standard 89/336/EEC.

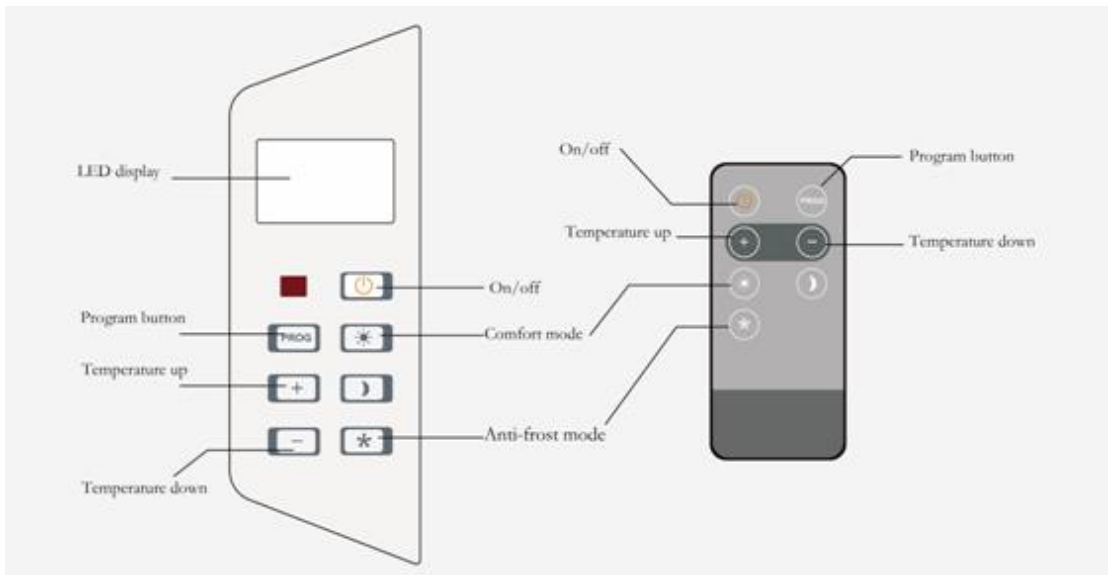

5. Control panel instruction

Control panel is shown below:





(1) On/Off “” button: a. Press “”. The heater starts working. When the heater is working, press “” again, the heater stops working and turns into stand-by state.

(2) “**PROG**” button: Press this button for 3 seconds to enter into the programmed mode, and shift the date by pressing the “**PROG**” button.

(3) Working mode button:

“” : the temperature can be set between 5 and 35°C.

“” : the temperature can be set between 5 and 25°C.



“” : the temperature can be set between 5 and 15°C.

(3) “”、“” button:

a. Under the working mode, press this button, the temperature can be regulated from 5 to 35 degrees. Each press of the button, the temperature will be increased or decreased by 0.5 degrees. If press the button over 3 seconds, the temperature will be increased or decreased by 0.5 degrees at a speed of 0.3 seconds. Once the temperature is set, if there’s no other operation, the heater will judge this setting as a definitive setting. (The factory’s preset temperature is 35 degrees, and the new set temperature will be stored in the memory).

b. Under time set mode, press this button to set current time.

c. Under working mode state, Press this button to regulate the 3 working modes’ working time respectively.

d. When the heater is working, press “” or “” button ,the screen will indicate the setting temperature.



(4) Lock/ Unlock button

a. Under the locking state, press the button “” on the control panel or on the remote control for 3 seconds and the heater will be unlocked.

b. If no button is pressed within 60 seconds, the button on the heater becomes locked on the display “”.

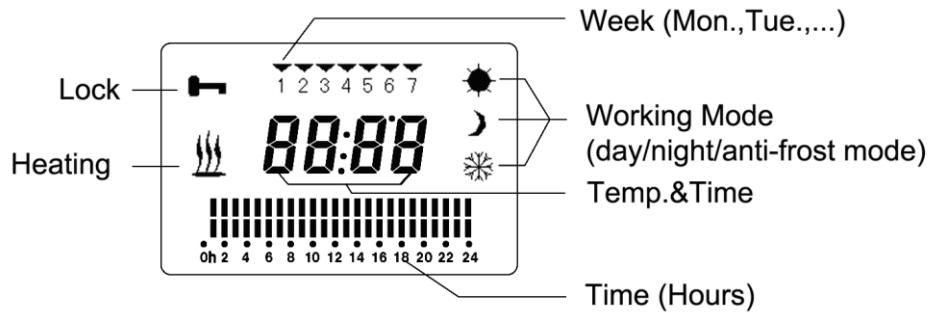
(5) Instruction for LCD as below:



When setting the heater, the display's background light is blue and after the setting been finished for 10 seconds, the blue light will be off. The LCD will indicate the room's temperature (shown as below) when the heater is under normal working and standby state. When the heater is heating, the power indicator “” will appear on the LCD. When the heater stops heating, the power indicator “” will disappear on the LCD





6. Operation instruction

(1) Turn on: Plug in, and turn the power switch on, the heater will be under the standby state and the display will indicate the room's current temperature. By pressing the on/off “” and the plus “+” button, the heater will begin the heating operation.

(2) Working mode and temperature setting: they can be set when the heater is turned on, and the button is not locked:

a. Comfort mode (Choose this mode when a relevant high room temperature is needed): Press the button “” to enter into the comfort mode. By pressing the button “+” or “-” to regulate the temperature. When the room's temperature reaches the set temperature, the heater will stop heating and when the room's temperature drops 3 degrees, the heater will start to heat automatically. The room's temperature will keep stable at the range of the setting temperature.

b. Economy mode: Press the button “” to enter into the economy mode. By pressing the button “+” or “-” to regulate the temperature.

c. Anti-frost mode: Press the button “” to enter into the anti-frost mode. By pressing the button “+” or “-” to regulate the temperature.

(3) Programmed operation setting: If you want the heater to run according to the programmed temperature every day, you need to set the programmed operation first.

The setting sequence is as below:

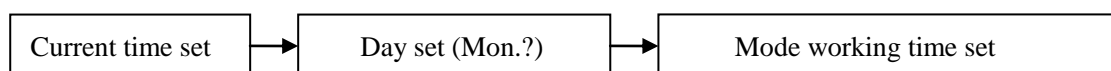

- a) Current time set: Press the button “**PROG**” for 3 seconds to enter into the time setting interface (shown as below):



The first two digits are for the hour flash, by pressing the button “+” or “-” to regulate the current hour then press the button “**PROG**” to enter into the minute setting. By pressing the button “+” or “-” to regulate the current minute.

- b) After the time setting, press the button “**PROG**” to enter into the week calendar set interface (shown as below). “**1**” stands for Monday (first day to program).

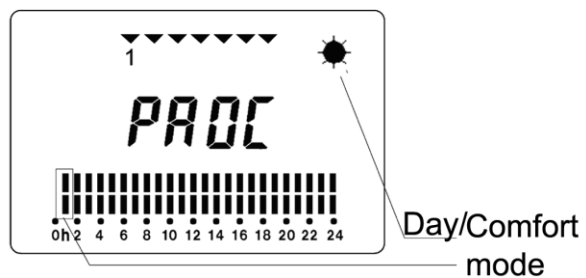
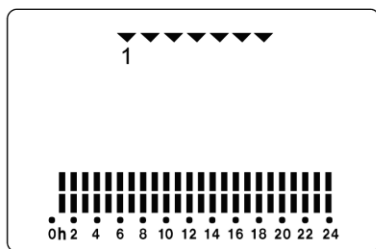

1. Set the day of the week (1 for Mon. and 7 for Sun.) by using the button “+” or “-” and pressing the button “**PROG**” to set.
2. By pressing the “+” or “-” to regulate the working time (0-24hrs) of each mode.
3. By pressing the mode button “☀️”, “🌙”, “❄️” to choose the working mode for every time period. When a time period’s setting is finished, press the button “+” or “-” to enter into the next time period’s setting. For example, the left picture shown as below means that the anti-frost mode starts to work on Monday at 0:00 hour, and the right picture shown as below means that the economy mode starts to work on Monday at 0:00 hour, and the right picture shown as above means that the comfort mode starts to work on Monday at 0:00 hour.

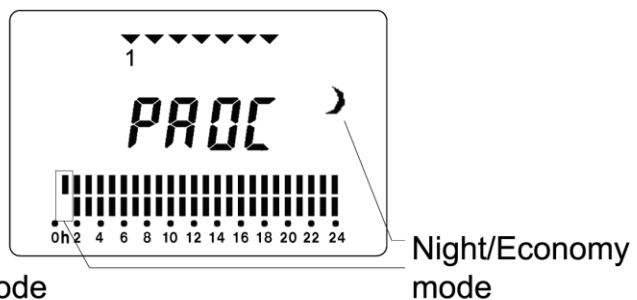
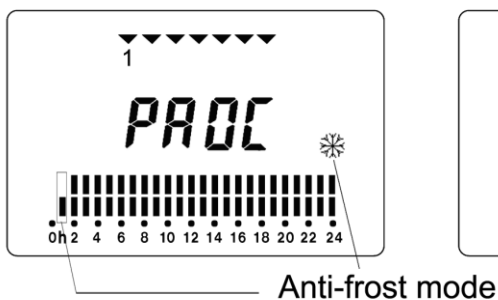

4. When Monday's setting is finished, press the button "PROG" to enter into Tuesday's setting. Set the Monday to Sunday's program in the same way and once finished, pressing the "PROG" and the program will be repeated weekly as long as the heater is not powered off or been turned off by the switch.

(4) a. When the heater is working and under the unlock state, press the "+" or "-" and the display will indicate the set temperature.

b. When the heater is under the comfort mode or economy mode or anti-frost mode, press the button "+" or "-" and you can enter into the temperature set mode. By pressing the "+" or "-" you can regulate the temperature.

7. Power off/ power switch off

The heater will stop working if the power switch is turned off or there's a power cut off. The time clock will stop at the power off moment, and all setting will be stored in the memory. Once powered on, by pressing the "+" or "-" and the heater will restart to work.. The time clock will go on moving from its powered off moment and all programs will continue running until reset the time.

8. High temperature protection

The heater transfers the heat through convection and radiation. Cover this heater by textile products in whole or in part will affect the heater's function and also result the heater itself in a high temperature. No textile products cover the heater otherwise it may destroy or block the air circulation and cause low efficiency for several products.

9. Daily Maintenance and cleaning

Before cleaning or maintaining the heater, plug out the power socket and wait until main body of the appliance is completely cool.

Do not require special technical maintenance.

A vacuum cleaner and soft brush can be used to clean the surface of the heater..

Stains can be cleaned by wet rag with cleanser and water.

10. Fault Detection and Solution

Ensure the power is connected

Ensure the appliance is switched on and the LCD light is on.

Ensure the setting temperature is higher than the room's temperature.

If problems still exist, contact technical support.

This appliance is marked according to the European directive 2002/96/EC on Waste Electrical and Electronic Equipment.



Do not dispose the heater as living garbage when it is end of life.

It must send to the local special recycling center or distributors for disposal.

Appliances should be disposed separately to avoid mistake disposal leading negative effect to the environment and sanitation. Main components of the heater can be recycled to save energy and resources. In order to remind users that the appliance should be disposed separately, there's a cross trash can mark on the product.